

FACADE POSTERIEURE

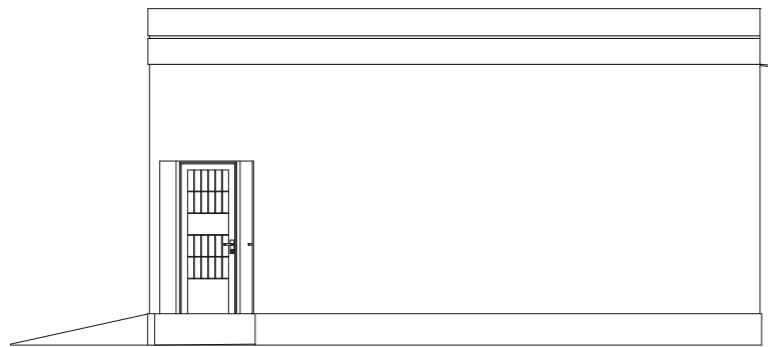

PIGNON DROIT

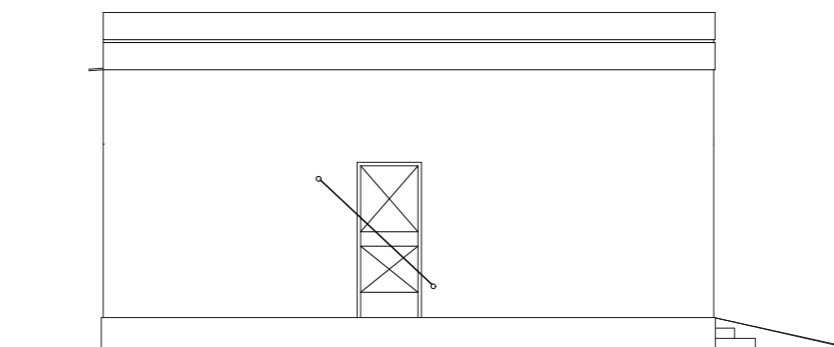

PIGNON GAUCHE

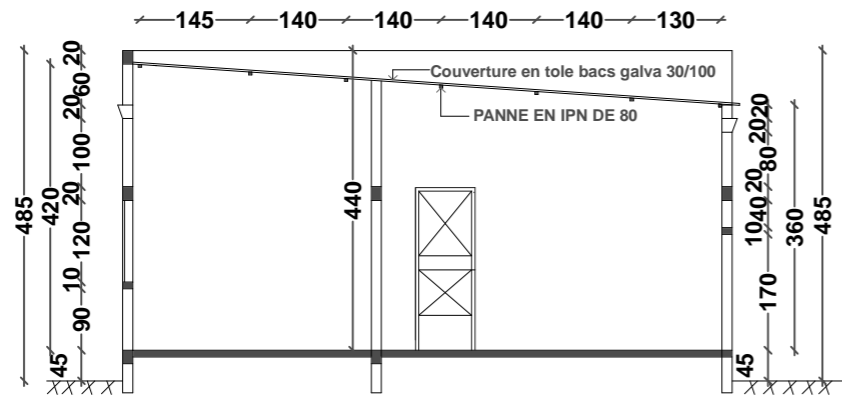

COUPE B-B

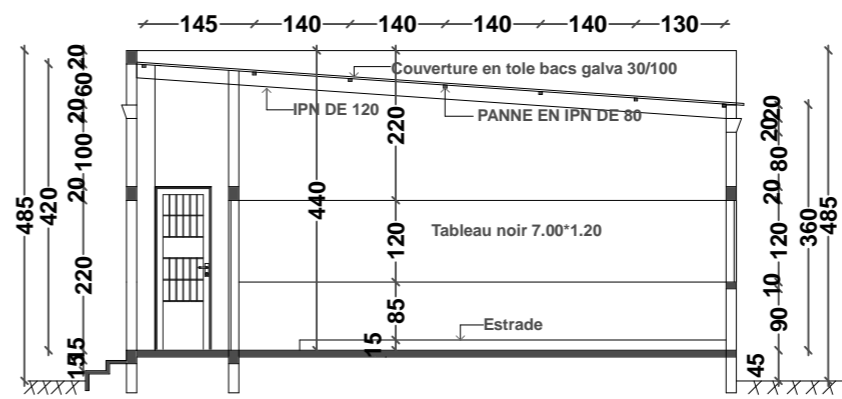

COUPE A-A

### ECOLE A TROIS (3) CLASSES

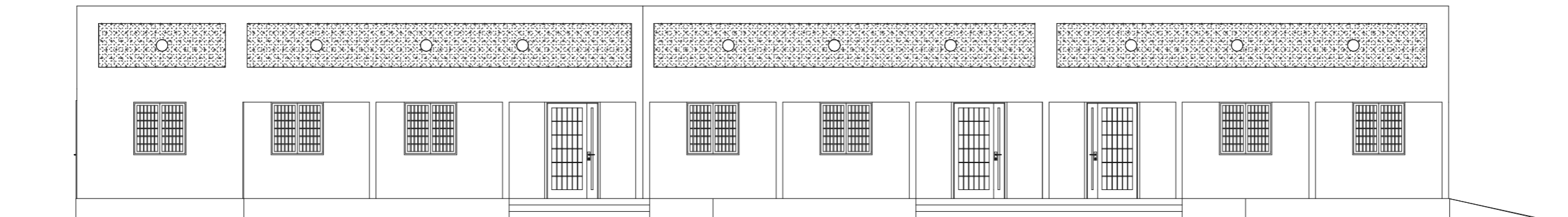

FACADE PRINCIPALE

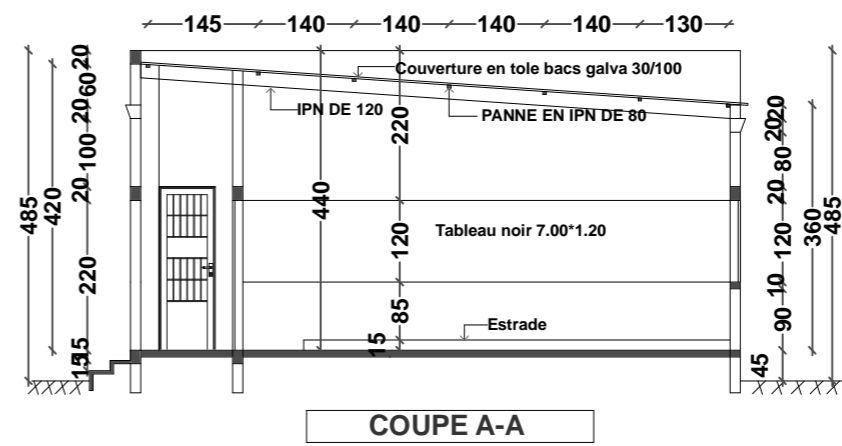
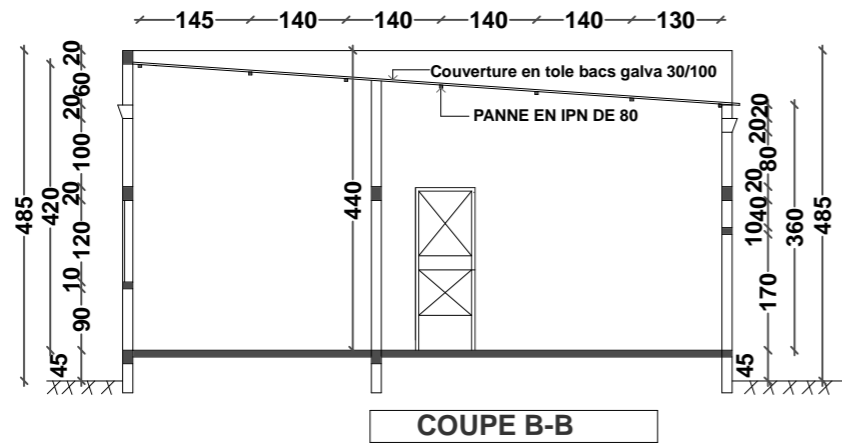

## ECOLE A TROIS (3) CLASSES

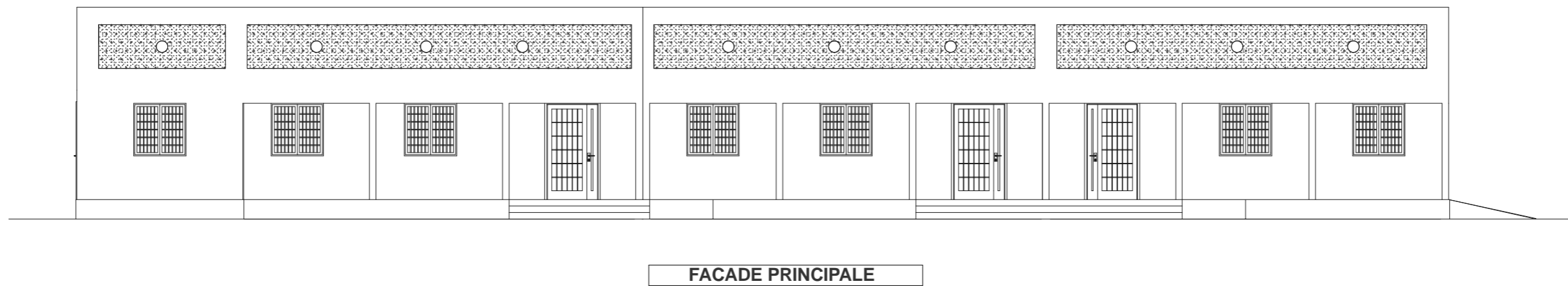

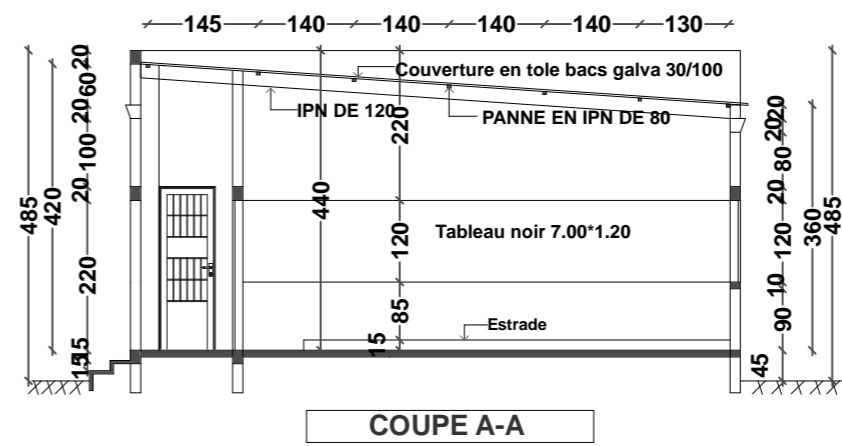
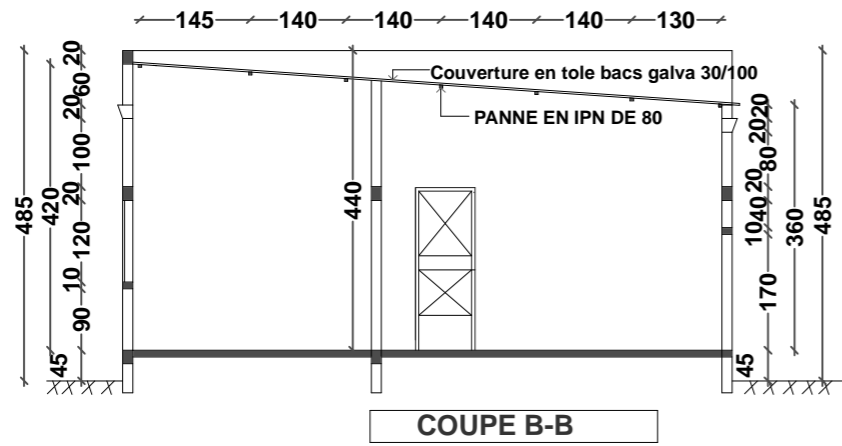

## ECOLE A TROIS (3) CLASSES

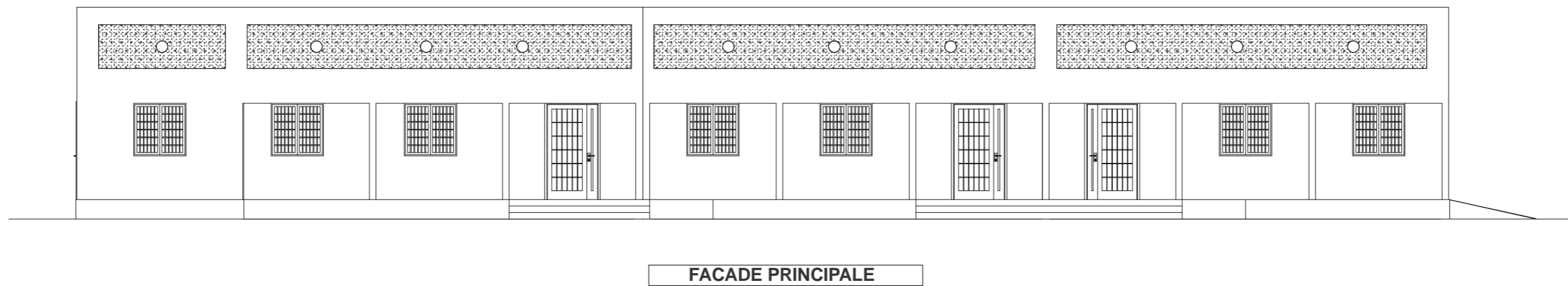



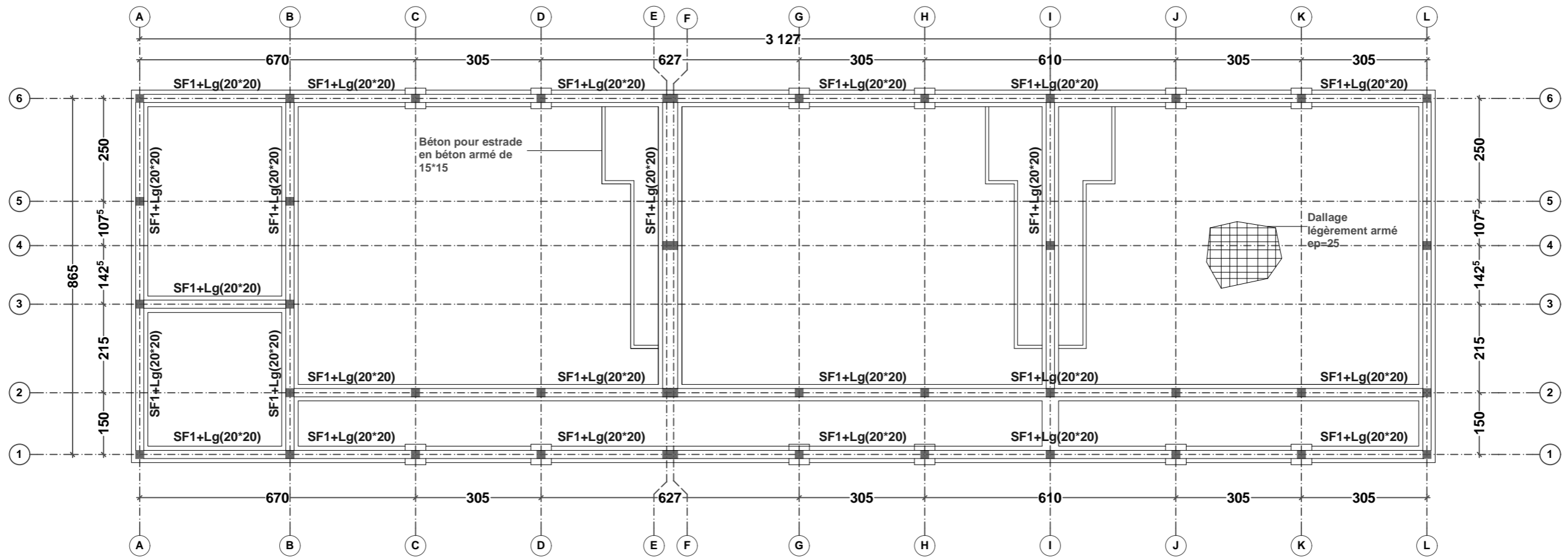

PLAN DE FONDATION

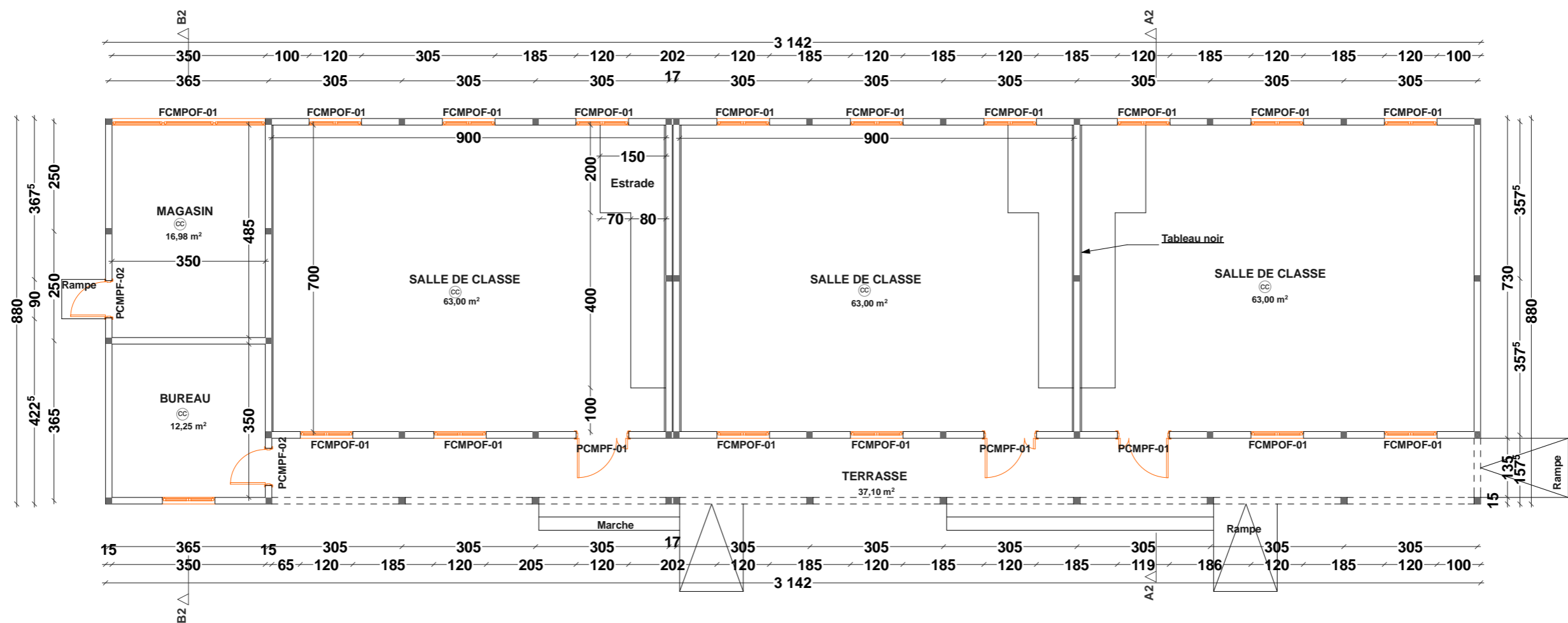

PLAN DE NIVEAU

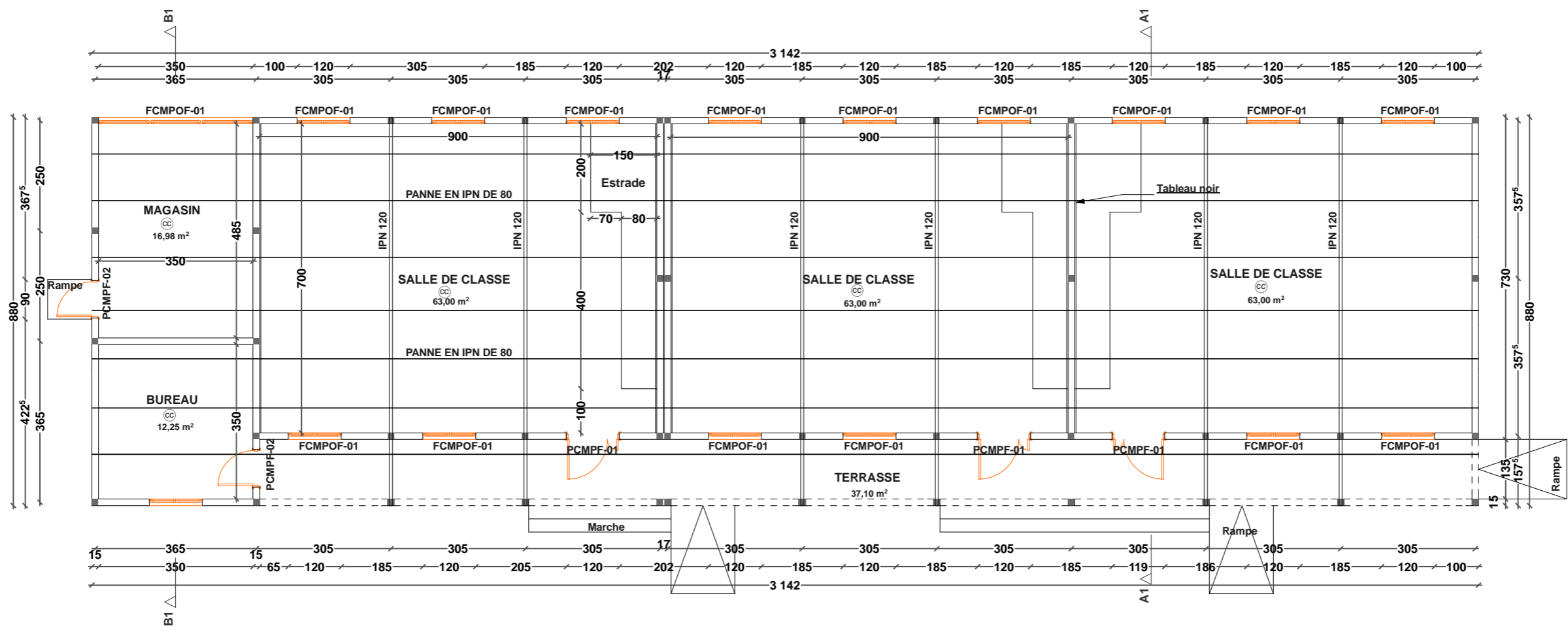

DETAIL TOITURE ET DE LA CHARPENTE